

DA ECO PHILOS

estal

www.estal.com
+34 972 821 676

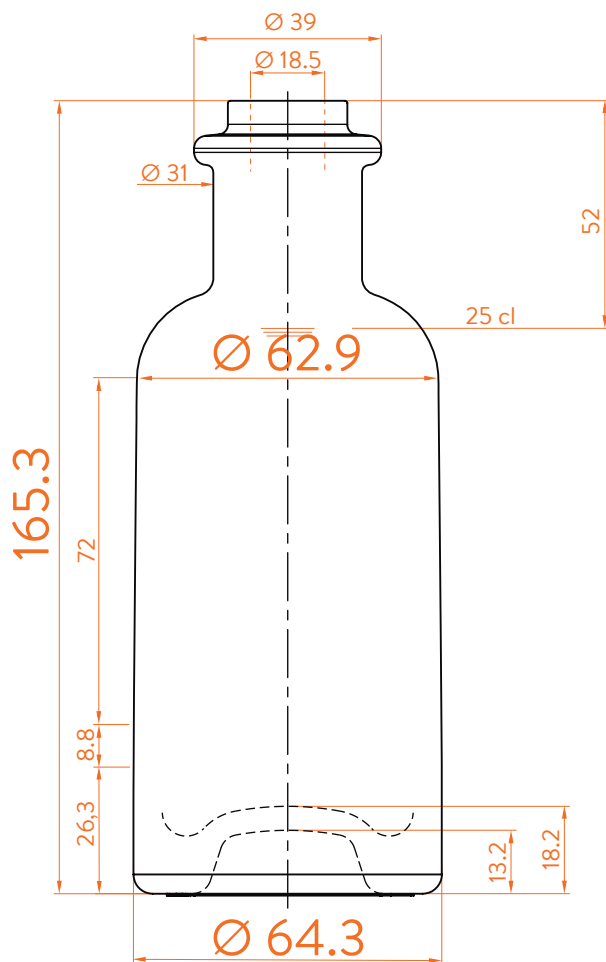

Modelo registrado/
Registered model/
Modèle enregistré



- EXTRA FLINT
- FLINT WILD GLASS



DATOS TÉCNICOS TECHNICAL DATA DONNÉES TECHNIQUES

Peso / Weight / Poids	335 gr
Altura total / Total height / Hauteur totale	165,3 mm
Diámetro del cuerpo / Body diameter / Diamètre du corps	64,3 / 62,9 mm
Ø interno boca / Ø inner mouth / Ø intérieur bouche	18,5 mm
Capacidad a verter / Brimfull / Capacité Ras-Bord	275 ml

25 cl

At first the DA ECO PHILOS range is proposed in 5, 10, 25, 50, 70 and 75 cl.
Following business opportunities, other sizes - from miniature 5 cl to big sizes 300 cl will be added to the range.

The elements detailed in this document are not contractual. They are only indicative.